

THIS MAP WAS PREPARED FOR ASSESSMENT PURPOSE ONLY

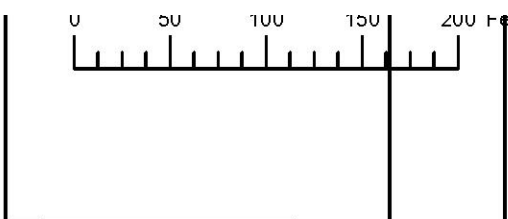

S.W. 1/4 S.W. 1/4 SEC. 18 T.4S. R.40E. W.M.

UNION COUNTY
1" = 100'

SEE MAP 04S 40E 18CB

04S40E18CC
UNION

Cancelled

600
2001
3300
3600
3800
4004
4501U1 THRU 4501U3
5100
5200
5700
6000

072-1977

1/16 COR

DELTA

(FIFTH AVE)

ST 072-1977

1/16 COR

83-71 (Missing)

DELTA

ST (OLIVE)

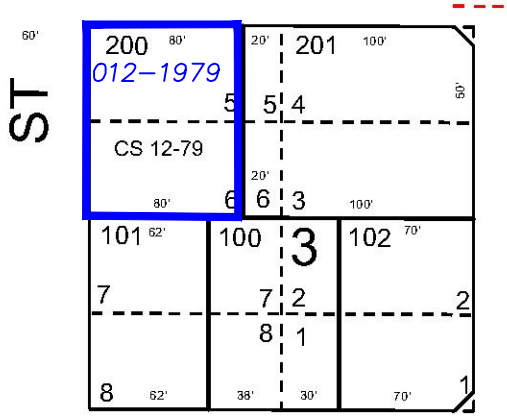
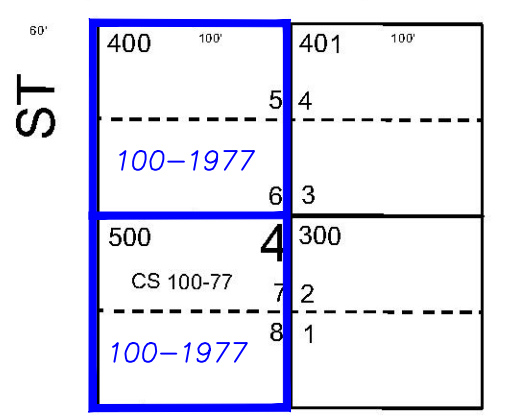
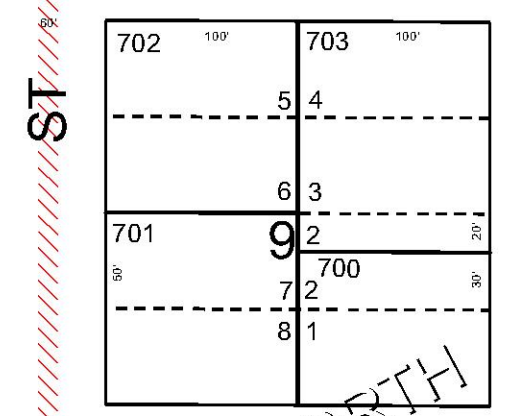
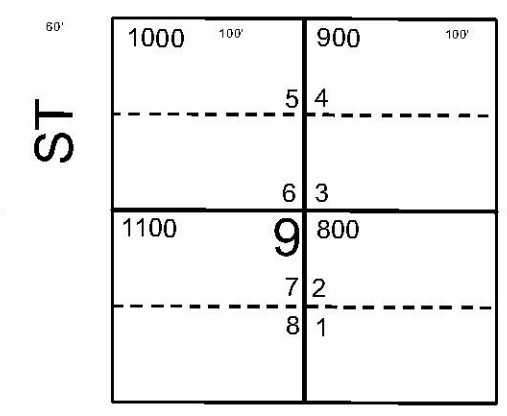
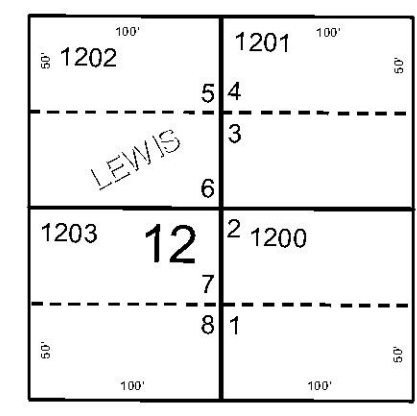

CHESTNUT

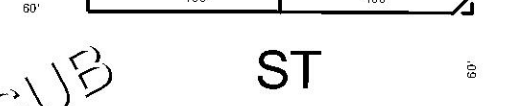
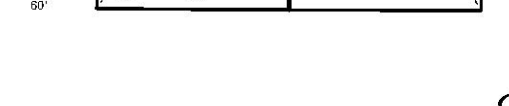
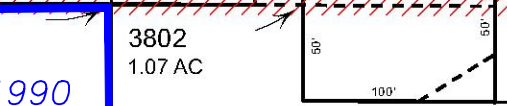
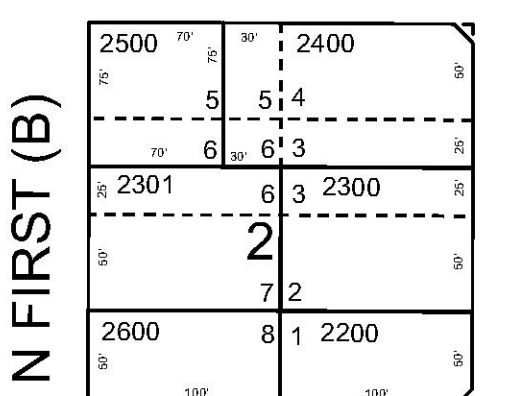
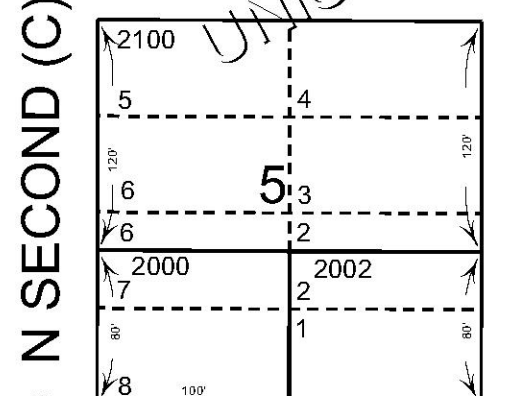
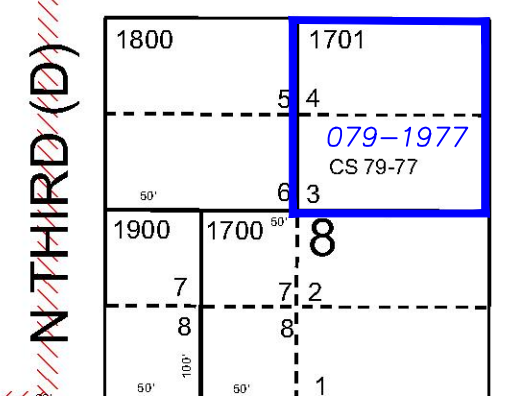
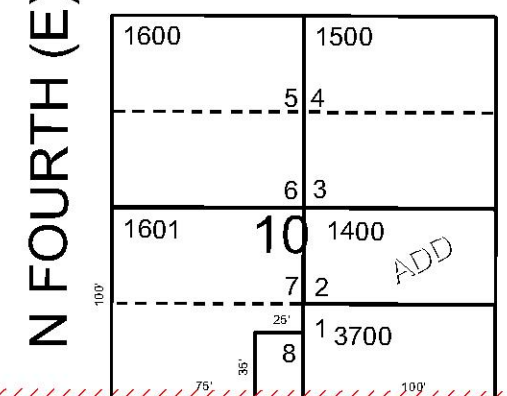
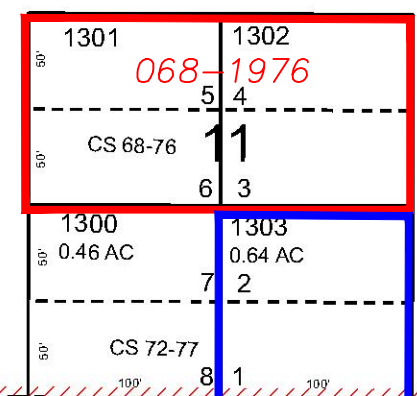

ST (N FIFTH)

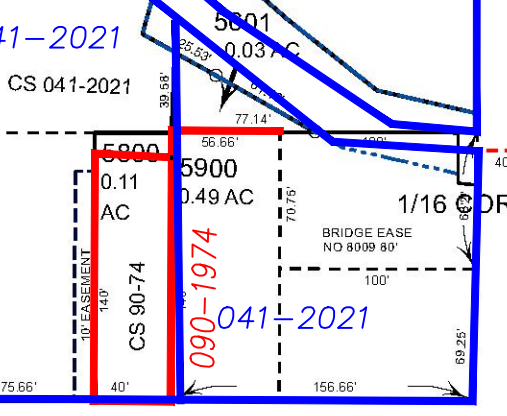
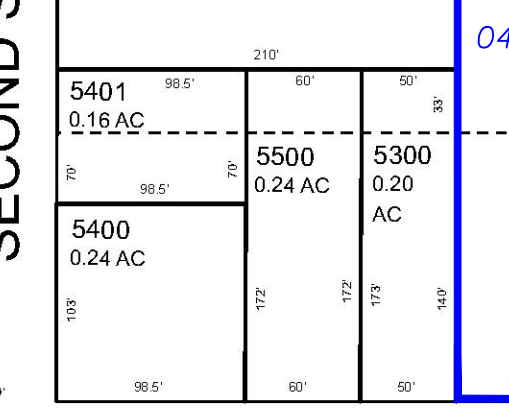
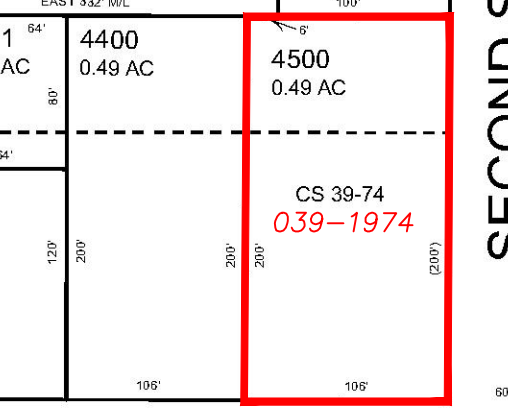
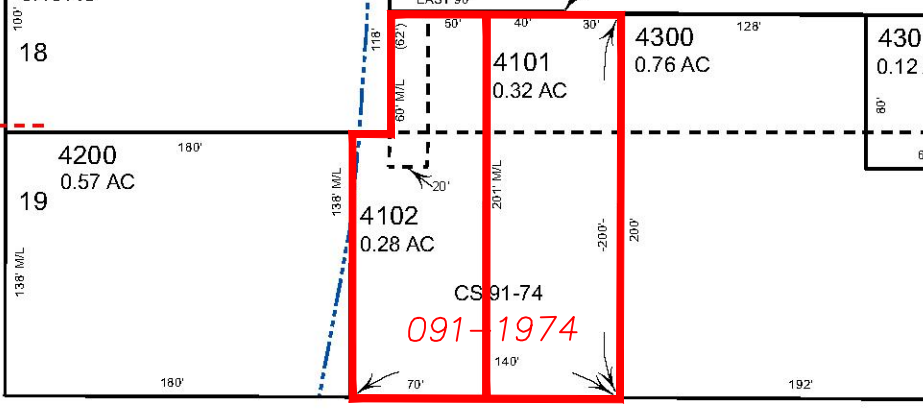
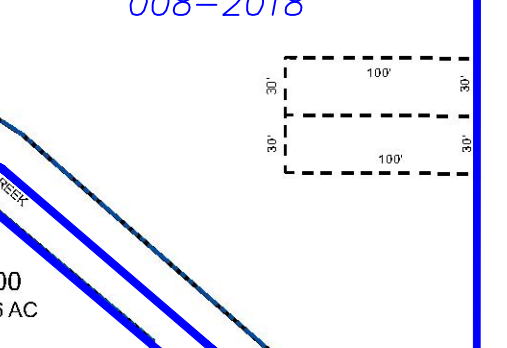
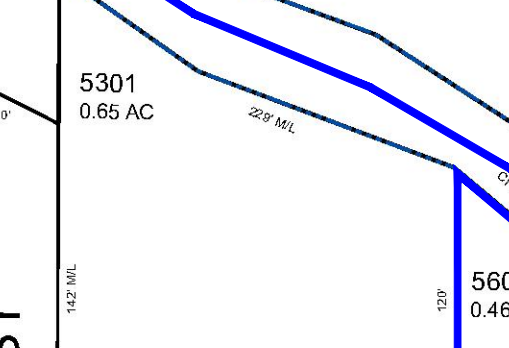
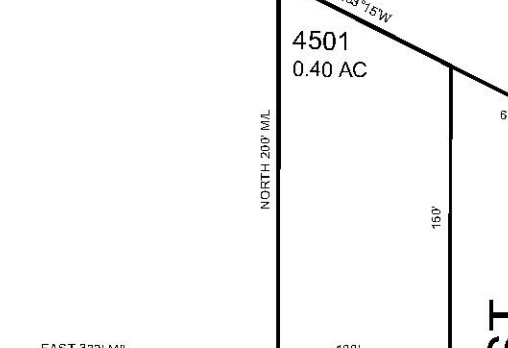
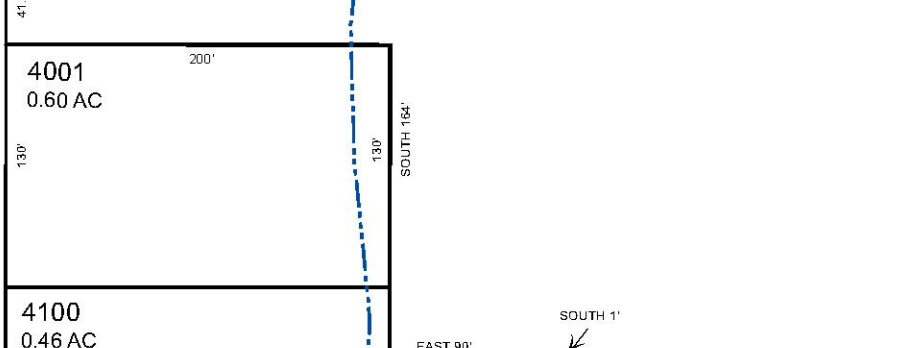
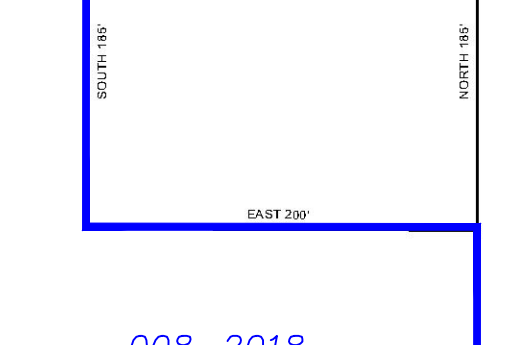
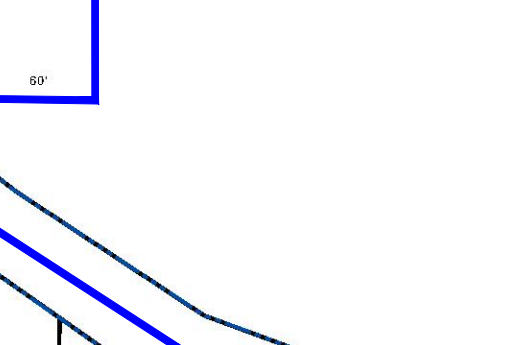
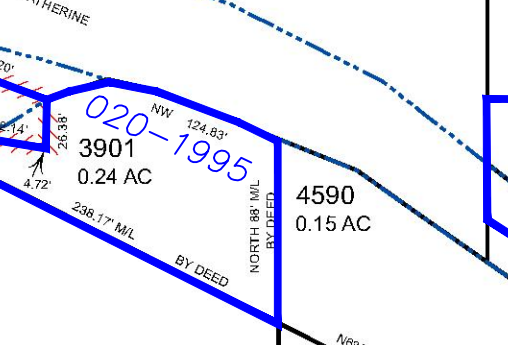
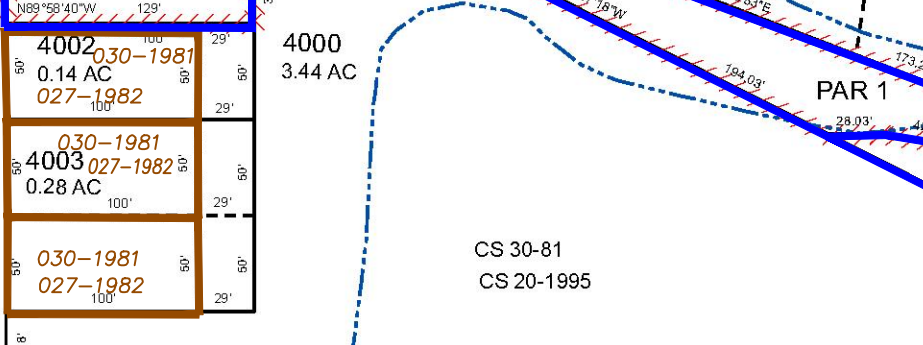
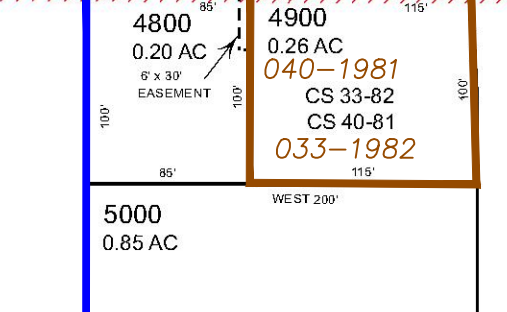
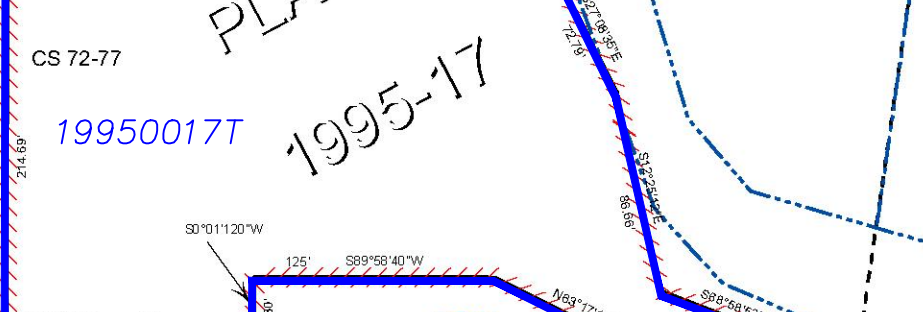
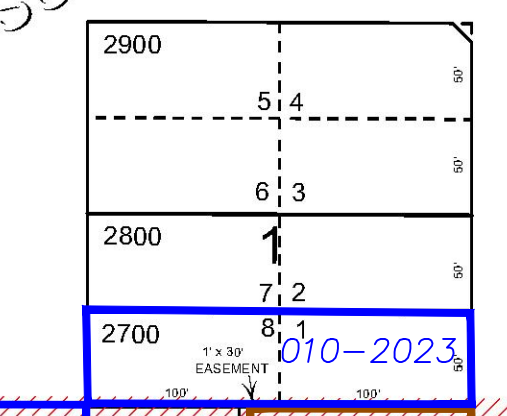
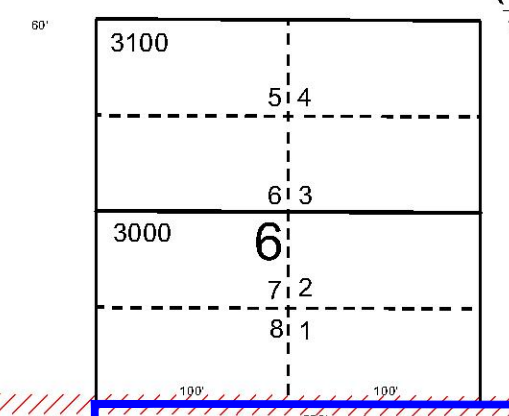
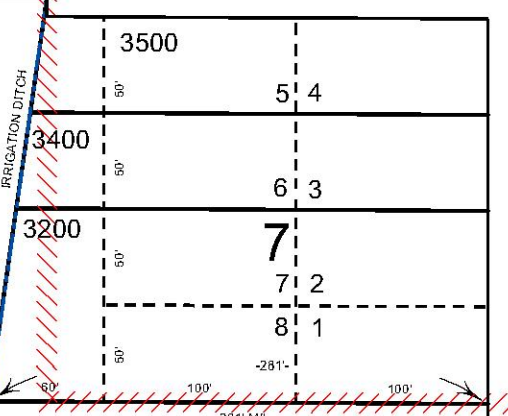
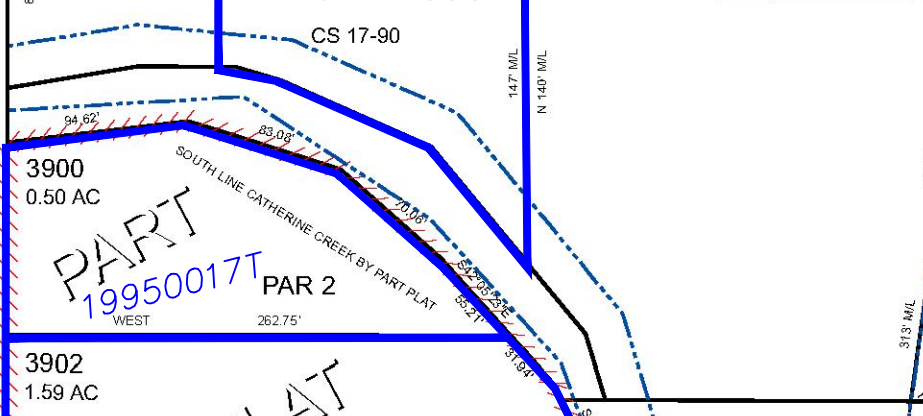

ST (ARCH)

ARCH

(A)

ST

042-2020

04S40E18CC
UNION

- BGB Survey
- APA Survey
- Survey by Others
- Voelz Survey
- Old Book Survey

Subdivisions on This Page

LEWIS ADDITION
NORTH UNION

SEE MAP 04S 39E 13DD

072-1977

13

24

SEE MAP 04S 40E 19BB

ODOT Control
Pt ties by
Survey Nos.
012-1992
054-1998

072-1977

SEE MAP 04S 40E 18CD

083-1971 (Missing)

ODOT Control
Pt ties by
Survey Nos.
012-1992
054-1998

PRINTED ON
Date: 6/7/2023

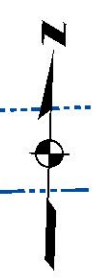

CATHE